



Smart Surveillance Camera

Motorized Pan Tilt / Tracking

SD Card Recording / Plug & Play

Installation Guide

1. Check Package Contents

⊙ The Smart Surveillance Camera



⊙ Remote Control



⊙ A/V cable



⊙ Power Adaptor



⊙ Installation Guide

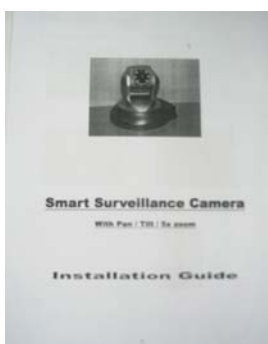

⊙ Camera Stand



2. Physical description

◎ Front Panel

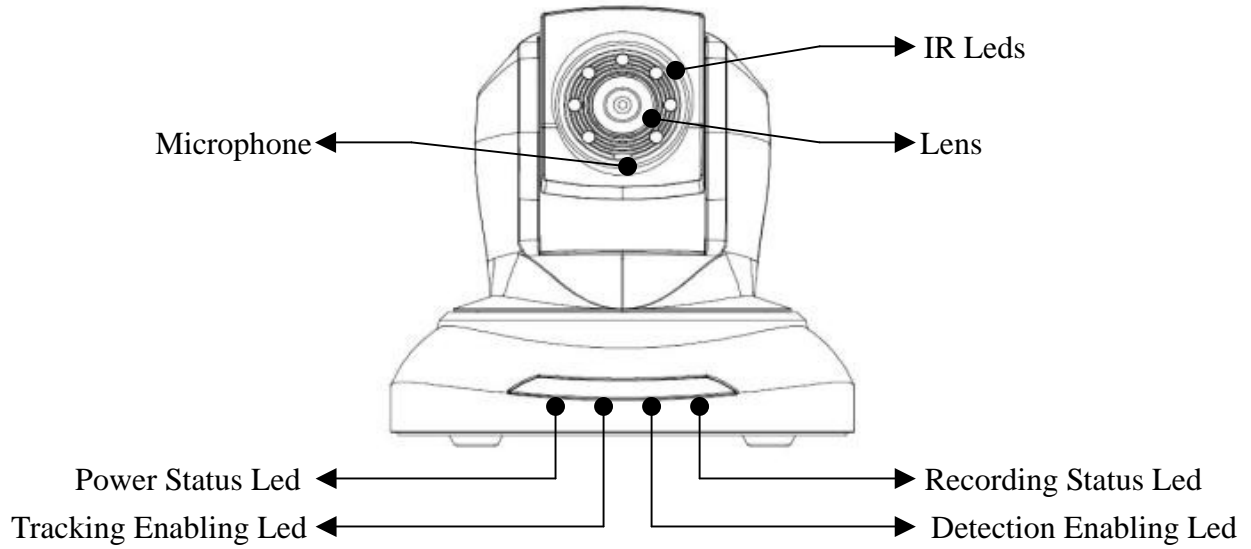

◎ Rear Panel

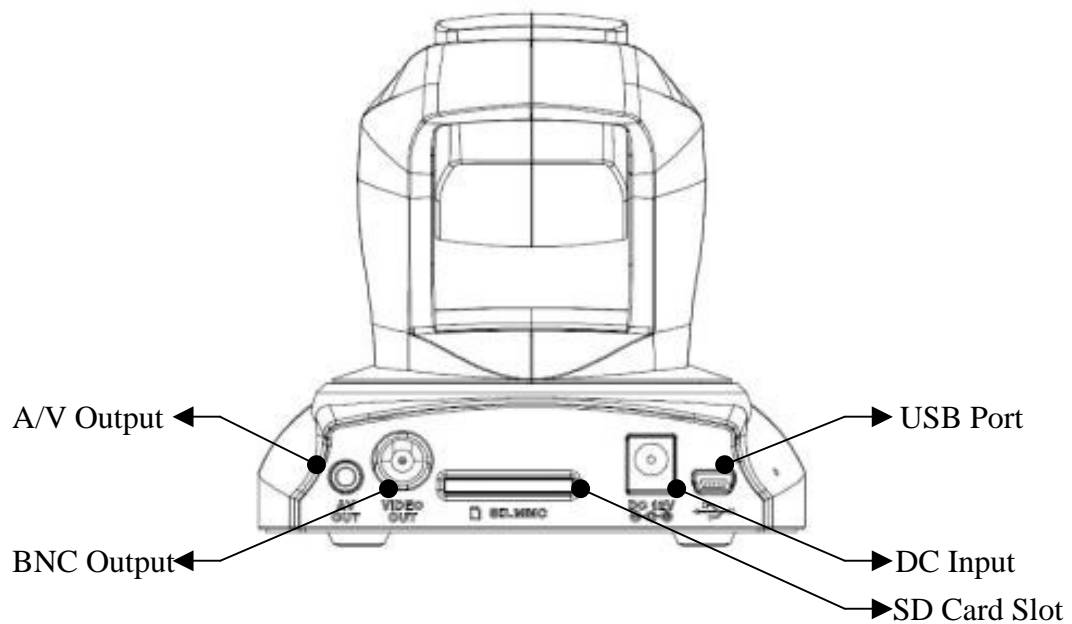

3. Operation Guide

3.1 Install the camera

1. Take out the power adaptor put in the package and plug into the camera. Don't use other power adaptor that may cause damage to this camera.
2. Connect the A/V cable to monitor or TV. You could unplug the audio terminals(red & white) if there is echo effect when it's short distance from the camera to TV. Make sure all cable connection is well connected. After the camera's self - rotation and then wait few seconds, you can see the live video on the monitor or TV.
3. The camera can be placed on a flat table. For surveillance purpose, if it's necessary you can use the mounting stand to mount the camera on anywhere such as wall, ceiling, ... etc.
4. If the camera is mounted up side down on the ceiling or you get a reflected video. In order to see the right view of picture, please enter the setup page to change the video setting to be flip or mirror.
5. The camera is capable of connecting DVR by using the BNC output connector.
6. After the camera is well installed, you can use remote control to move the camera's head to certain direction. The camera is designed with very wide range of pan/Tilt angle - Pan : Range 355 degree, Tilt : Range 135 degree
7. During the preview mode and recording, the camera is allowed to move its head by remote.
8. During the preview mode, recording and playback, you could click zoom+/- to adjust the picture size up to five times. Under the zoom status, you could use arrow keys to move the video or picture to see the full range.

3.2 Menu setup

1. Press setup to enter the main setup page. On this page, press setup again could return to preview mode directly. Please enter the time and date firstly. Some settings related to schedule setting may need the correct time and date. Use arrow keys to adjust the time and date and press enter to jump to next setting. After setting, move the cursor to lowest item(main page) then press enter to return to main setup page.

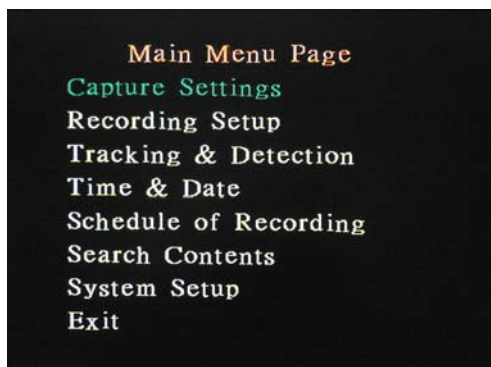

2. When entering the system setup page, you could do some basic settings. Default setting of TV system and power frequency should be correct. You can also change it through the system setup

page or press “pause” key for about three seconds to automatically switch the TV system.

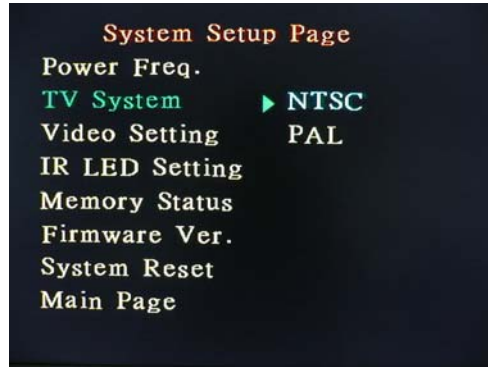
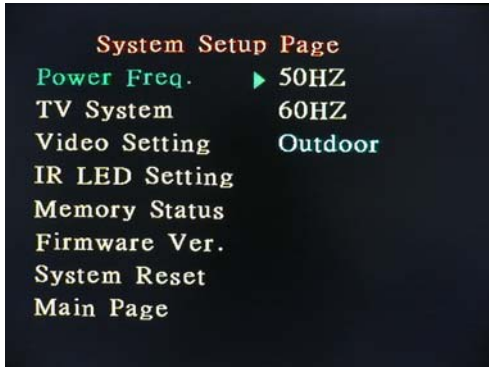

3. In video setting, you could change the video to be mirror or flip. In IR Led settings, you could set the IR Led light status to manually, auto or schedule setting. During the night, the IR LED could help to see a clear image with black and white color.

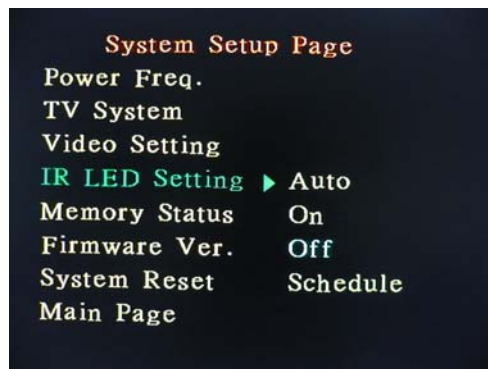
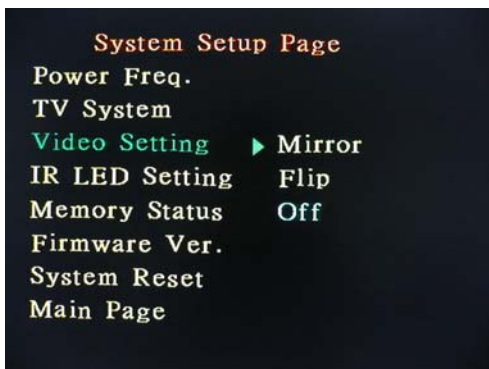

4. The camera provides system information about the remained space of the SD card or flash memory and firmware version.

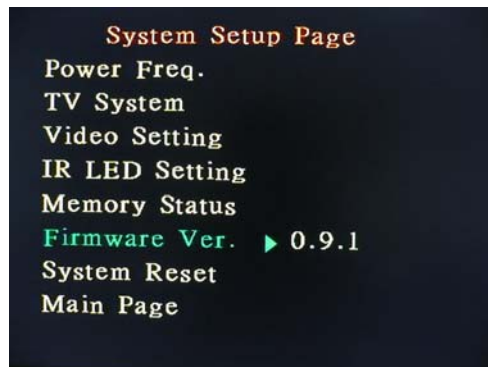
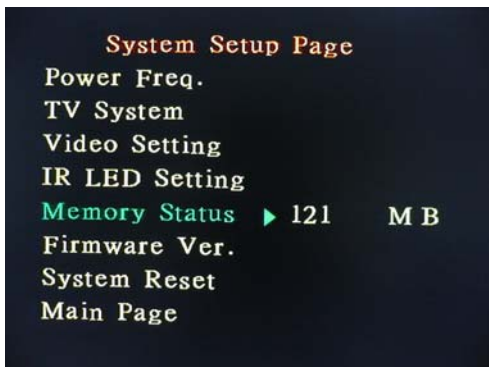

5. Entering system reset and select the default setting will restore all settings to be default settings. Selecting “Format” will clear the space of present storage media after double confirmation.

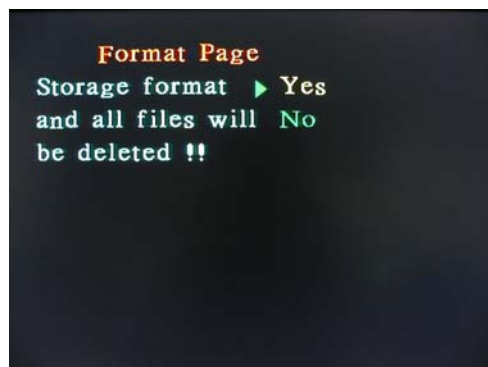
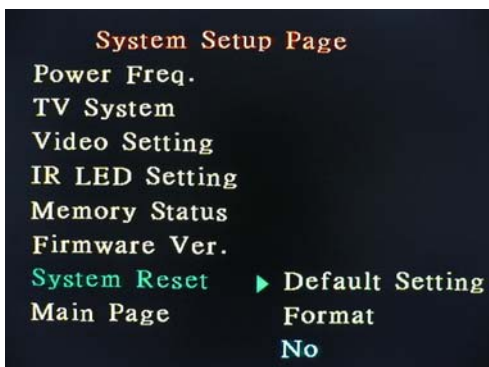

3.3 Capture and Recording

1. If start capture or recording, please insert SD card to the camera since the built in memory size is limited. You can see the detection of SD card on the picture.
2. When capture pictures, you could select the capture mode to be sequence (three pictures) or single. You can change the capture angle by moving the camera's head from the remote control and push the capture button to get pictures.
3. In capturing, you could also change the resolution setting and image quality. The picture resolution could be set from range 640*480 to 1280*960.

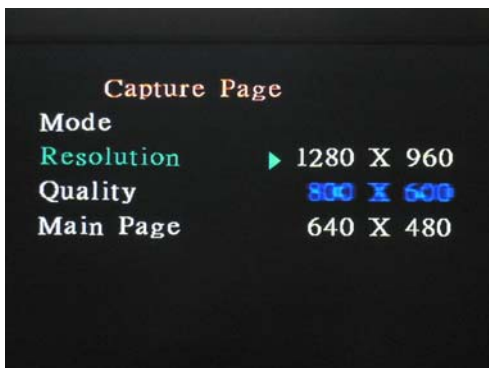
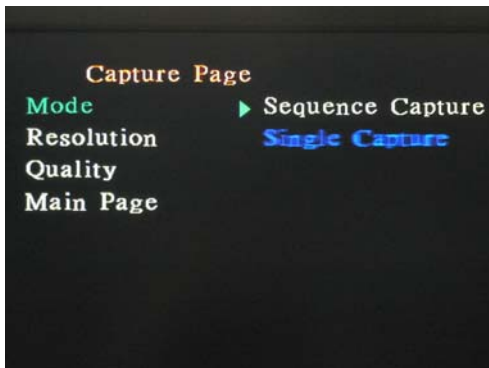

4. Similar to setting capture, the recording could be set as continuously or records only for 10 or 30 seconds when pressing REC button. When the recording is continuous, the recorded file will be split into several files to five minutes for 640*480 and ten minutes for 320*240 resolution.

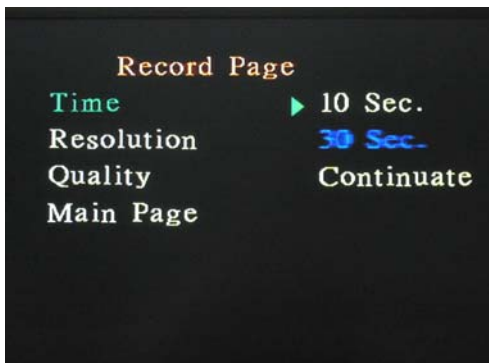

5. In recording, you could also change the resolution setting and image quality. The video resolution could be set from range 320*240 to 640*480. The size of recorded video is related to settings of resolution and compression quality. Basically the size is small because it's in high ratio compression. The file size has been shown in product specification.

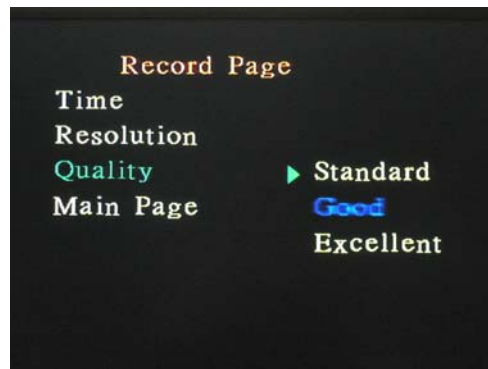
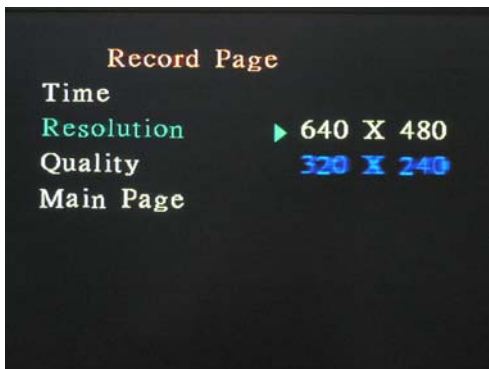

6. If you want to do schedule recording, please enter the setting page of schedule recording. There are several kind of selections. If you want to set a specific period even over one day for recording, please choose mode “Period” to set the date and time. Just set the recording time when choosing the mode “Daily”. If you select “Week”, please choose the days first then set the recording time.

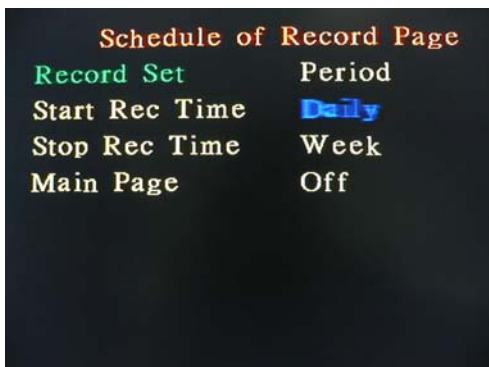
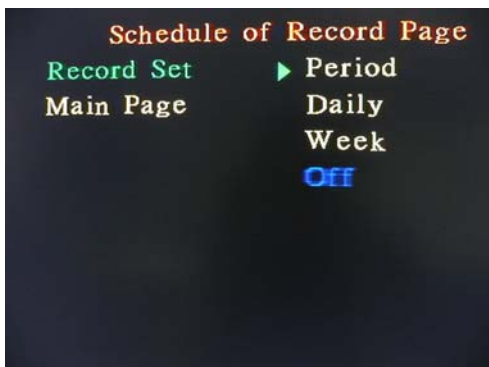

7. You must turn back to preview mode after schedule setting. During the schedule recording, you could do auto pan, zoom+/- at same time. Pressing stop will terminate the schedule recording.

3.4 Tracking and Detection

1. The camera provides special functions – tracking and detection. Move the camera’s head to the hot area before you start the tracking or detection function. You could press the remote control directly or enter the setup page.
2. When detection is on, the camera will start recording if something is moving in the preview area. Once the object moving is stopped, the record will be stopped in five or ten seconds.
3. With the tracking function enabling, the camera’s head could track the moving object and record the whole event. Once the object moving is stopped or gone, the record will be stopped in five or ten seconds and camera’s head will turn to the original side.

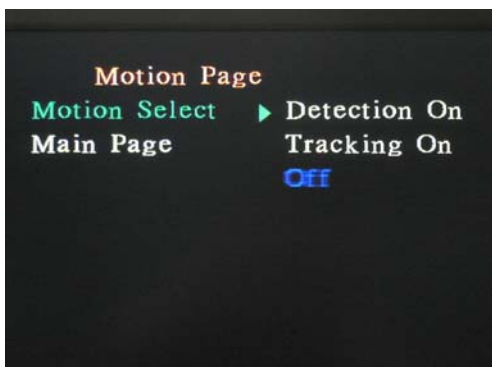

3.5 Playback

1. Pressing the button of “play mode” on remote control will switch in between the mode of playing contents and preview. Make sure to plug audio terminals(red & white), if recorded file includes audio. When entering the contents menu, use arrow key to select file, then press enter to start playback. You could press left/right key to move to previous/next file directly.

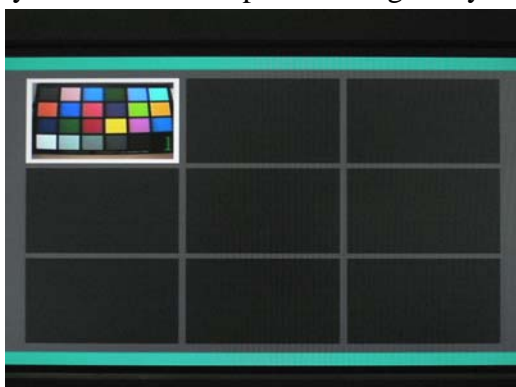

2. If there are too many files listed in the contents menu, wait few seconds to scroll the contents page when pressing key “FF” and “FR” on remote. For quick search, you could use the function “Search Contents” to find out the file in specific recording time.

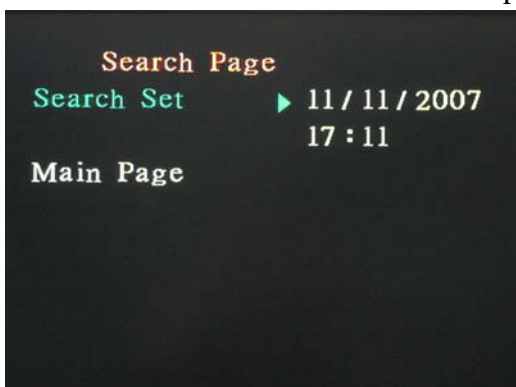

3. Under playing pictures, you have to press stop to return to contents menu. Under playing video, you could also return to contents menu when pressing stop or after the video finish.
4. The camera could be used as a storage device through the connecting USB2.0 to computer. When connecting to PC, the recorded files in either SD card or flash memory could be read from the computer.
5. If you want to play the videos on your PC, Firstly you need to install the XviD codec on your computer. To install the XviD codec, please download the latest version (or the version after

v1.1.3) of the codec available for your system and please follow the installation instructions:
<http://www.xvidmovies.com/codec/>

3.6 Cautions and Maintenance

1. Do not try to fix this device by yourself. Please look for the help from the dealer always if the device is out of order.
2. Do not manually rotate the camera when it is rotating driven by electrical power. That could damage the camera. Except for this situation, you could rotate the camera either by hand or use the remote control to pan and tilt the camera.
3. If it is necessary to clean the lens, please follow these instructions:
 - a. Prepare cotton swabs and alcohol.
 - b. Moisten the cotton swab with alcohol.
 - c. Slightly clean the lens.

If the lens is still dirty, repeat 2 ~ 3 steps until it is cleaned. Change a clean cotton swab if the old one is dirty or contains dirt that might scrape the lens. Never touch the lens hard.

4. Remote Control

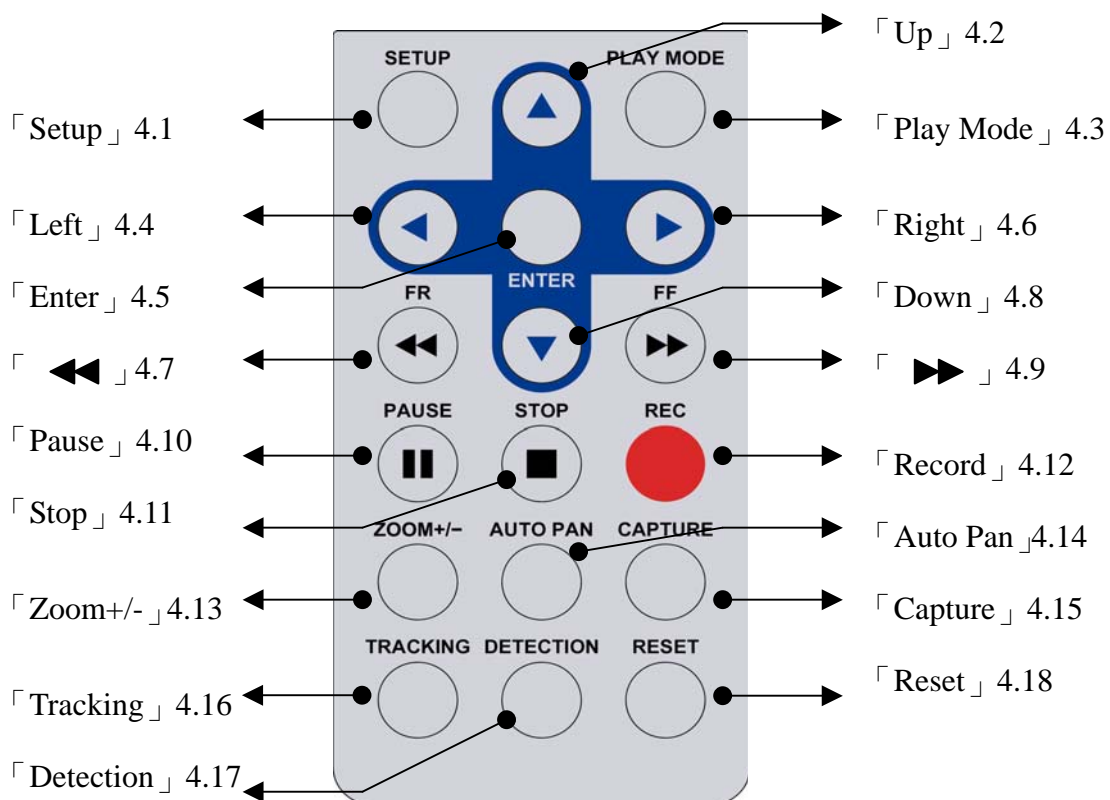

4.1 「Setup」

Switch the main setup page and preview mode.

4.2 「Up」

In preview mode, up key and other arrow keys will move the camera head to direction accordingly. On main setup page or in play mode, up and other arrow keys are for choosing items.

4.3 「 Play Mode 」

Switch the play mode and preview mode. Press this button, you could play files in the SD card or flash memory.

4.4 「 Left 」

In preview mode, left key and other arrow keys will move the camera head to direction accordingly. On main setup page or in play mode, left and other arrow keys are for choosing items.

4.5 「 Enter 」

Press “Enter” to play the selected video/audio or confirm the new setup while in play mode or main setup page.

4.6 「 Right 」

In preview mode, right key and other arrow keys will move the camera head to direction accordingly. On main setup page or in play mode, right and other arrow keys are for choosing items.

4.7 「 Fast Rewind 」

Press this key, it will play the fast rewind.

4.8 「 Down 」

In preview mode, down key and other arrow keys will move the camera head to direction accordingly. On main setup page or in play mode, down and other arrow keys are for choosing items.

4.9 「 Fast Forward 」

Press this key, it will play the fast forward.

4.10 「 Pause 」

Press this button, the video playback will be pause, or keep for about three seconds to automatically switch the TV system.

4.11 「 Stop 」

Press “Stop“, the video playback will be stopped and return to play mode. It could also stop the recording.

4.12 「 Record 」

Press “REC” to record the video/audio at real time. When memory is full, the recording

will be continuous and automatically delete the oldest files. Before recording, you could enter the setup page and choose recording settings to do resolution setup.

4.13 「 Zoom+/- 」

In preview mode or recording status, you could press zoom to max. five times the picture. When in playback or still picture, you could also press zoom and use arrow keys to move the pictures.

4.14 「 Auto Pan 」

Press auto pan, the camera head will continuously move from left end to right end. The auto pan will stop if press it again.

4.15 「 Capture 」

Press capture to take photos.

4.16 「 Tracking 」

Press this button will enable the tracking function and start recording when object moving inside the surveillance area.

4.17 「 Detection 」

Press detection, the record will start when object moving inside the surveillance area.

4.18 「 Reset 」

Once the camera has been moved by hand. Press reset in preview mode, the camera will self rotate and turn to the original position.

5. Specifications

Key Features :

Smart surveillance camera for Home/Office security purpose

Record Audio/Video in SD card or built in flash memory

Motorized Pan/Tilt and 5x digital zoom

4 video recording modes : manual, schedule, motion detected and motion tracking

Easy OSD menu operating with IR remote controller

One key touch to start motion tracking or motion detection

Built - in microphone for audio monitoring

Quick recorded video search function and playback

Auto - Pan allowed

6 IR leds with auto light sensor for day and night monitoring

Video recording resolution 320*240 or 640*480 selectable at 30fps

Max. 4.2 hours recording time for 1GB SD card(support up to 8GB SD card)

USB 2.0 data storage center

Playback and monitoring function with composite A/V(NTSC/PAL) out

BNC output for DVR connection

Adjustable manual focus, auto white balance, auto exposure control

Pan : Range 355 degree, Tilt : Range 135 degree

Dimension : 105 x 105 x 100 (mm)

**Accessory : Power adaptor, Remote control, A/V cable, Quick Guide, Mounting Stand,
Battery(optional)**

Technical Specifications

- Video NTSC/PAL video system 30fps, 320*240/640*480 Recording quality : Standard/Good/Excellent	- Camera specification CMOS sensor, 300K pixels Fixed focal with fine tuning, 4.0mm, F2.0
-Output Composite A/V out BNC video connector USB 2.0 slot	- Audio Embedded CD quality audio codec. 44.1KHZ sampling, 80DB SNR Include an ALC(Auto level control) feature
- Pan/Tilt angle Pan : Range 355 degree, Tilt : Range 135 degree	- EMI & Safety CE, FCC
- Operating Environment Temperature : 0 - 40°C Humidity : 85% RH	- Dimension 105 x 105 x 100 (mm)
- Power DC 12V 1.5A (Rechargeable Li battery)	- Weight Net : 250 g(w/o battery)

-Storage for 1GB SD card (Recording time may change for different video content)

Video recording time		30fps, 320*240	30fps, 640*480
	Standard	250 minutes	70 minutes
	Good	210 minutes	60 minutes
	Excellent	170 minutes	50 minutes

-Storage for 8GB SD card (Recording time may change for different video content)

Video recording time		30fps, 320*240	30fps, 640*480
	Standard	2000 minutes	568 minutes
	Good	1664 minutes	472 minutes
	Excellent	1328 minutes	384 minutes